

Fitting for top-running wooden doors up to 80 kg (176 lbs.), with surface mounted running track or running track flush with the ceiling. Optionally with soft and self closing mechanism. Wall or ceiling mounting. Minimal installation height.

Product highlights

- Flexibility** Running tracks for wall and ceiling mounting with integrated clip-on system for clip-on panels
- Productivity** Tool-less door mounting

Technical specifications

- Max. 80 kg (176 lbs.)
- Max. 4000 mm (13'1 15/32")
- Max. 3000 mm (9'10 1/8")
- 35–80 mm (1 3/8" to 3 5/32")

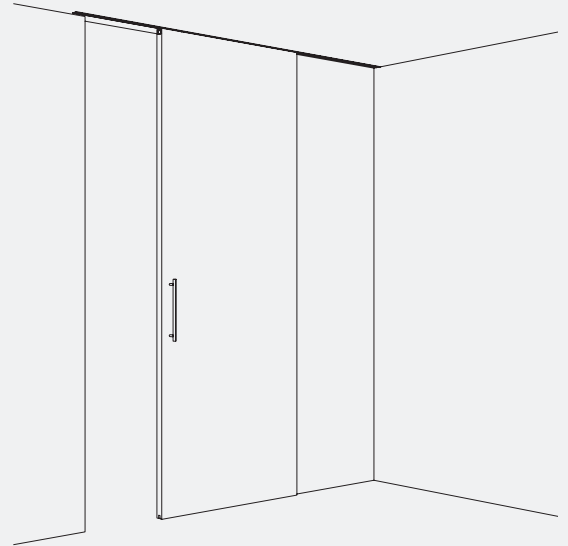

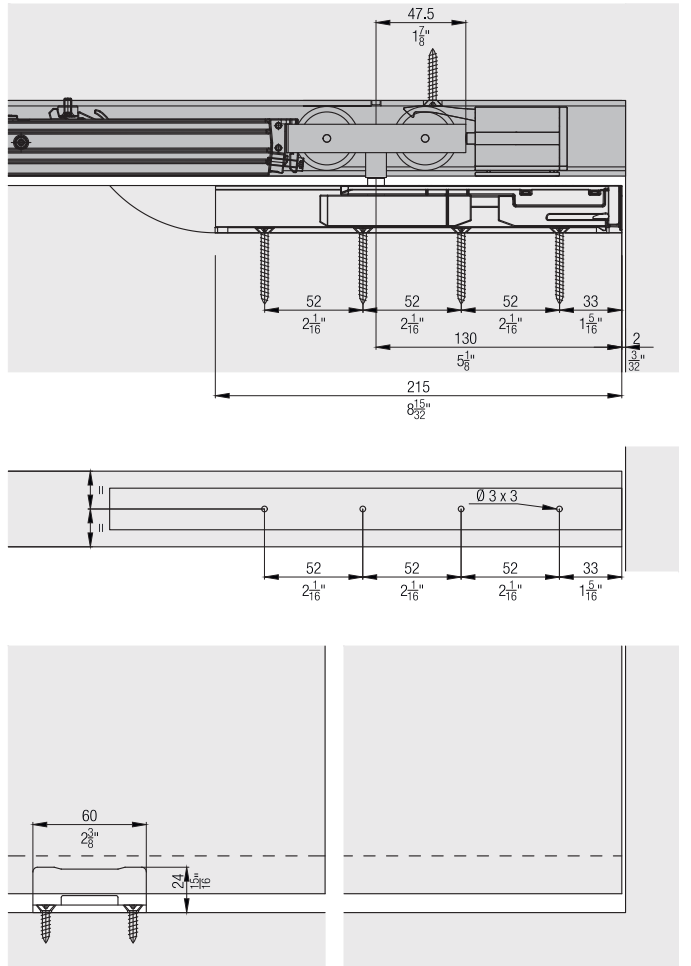
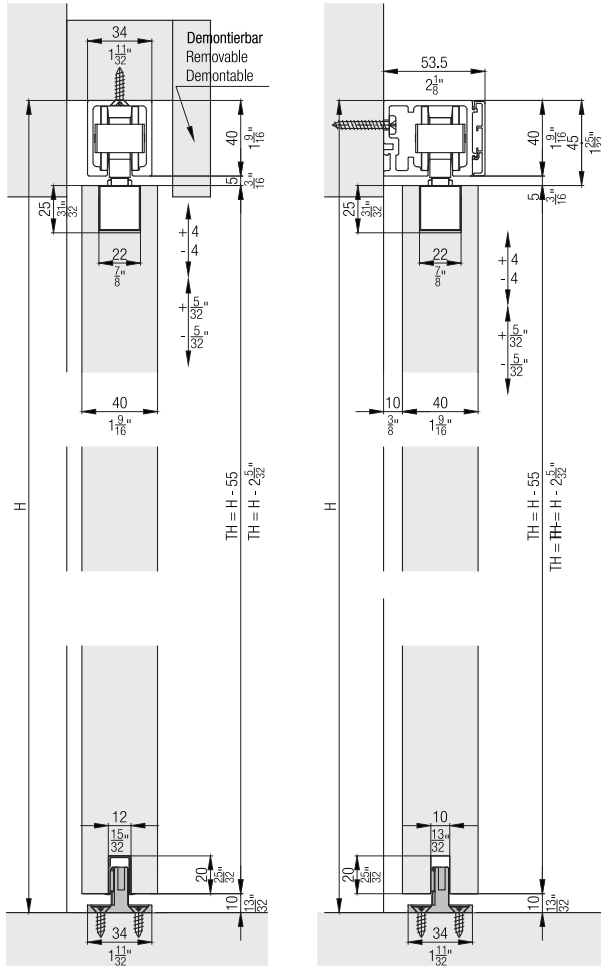

Installation examples





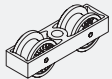
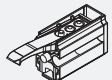
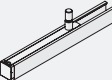
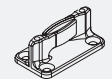

Set for 1 wooden door up to 80 kg (176 lbs.)

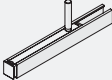
	No.
Hawa Junior 80 B, for 1 door	24617
Hawa Junior 80 B, with a 20 mm (25/32") longer suspension bolt M10, for 1 door	24851

Set consisting of:

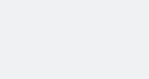
	24617	24851	No.
 Running gear, 2-wheeled, M10, plastic wheels	2	2	10407
 Stopper Hawa Junior 80/100, with adjustable retention spring	2	2	30138
 Suspension profile, plate with screw M10	2		24246
 Bottom guide, zero tolerance, groove width 10 mm (13/32"), plastic black	1	1	14427
 Screw-on rubber door stop	1	1	10629
 Suspension profile, plate, with 20 mm (25/32") longer screw M10, ceiling integration		2	24846

Running tracks

	mm (inch)	No.
	1,400 (4' 7 1/8 ")	10189
	1,600 (5' 3 ")	10190
	1,800 (5' 10 7/8 ")	10191
	2,000 (6' 6 3/4 ")	10192
	2,200 (7' 2 5/8 ")	10193
	2,500 (8' 2 7/16 ")	10194
	3,000 (9' 10 1/8 ")	18532
	4,000 (13' 1 15/32 ")	18533
	6,000 (19' 8 7/32 ")	10186
	cut to size	10188
	4,000 (13' 1 15/32 ")	20005
	6,000 (19' 8 7/32 ")	20004
	cut to size	20006
	2,000 (6' 6 3/4 ")	27673
	2,500 (8' 2 7/16 ")	30323
	3,000 (9' 10 1/8 ")	27672
	4,000 (13' 1 15/32 ")	30324
	6,000 (19' 8 7/32 ")	27671
	cut to size	27695
	2,000 (6' 6 3/4 ")	27677
	2,500 (8' 2 7/16 ")	30320
	3,000 (9' 10 1/8 ")	27676
	4,000 (13' 1 15/32 ")	30321
	6,000 (19' 8 7/32 ")	27675
	cut to size	27696
	2,500 (8' 2 7/16 ")	27664
	4,000 (13' 1 15/32 ")	27663
	6,000 (19' 8 7/32 ")	30325
	cut to size	27665

Guide tracks

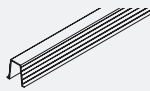
		mm (inch)	No.
	Guide track, for groove mounting, plastic, 10-piece set	1,300 (4' 3 3/16")	14540

Panels

		mm (inch)	No.
	Clip-on panel to running track, aluminum, anodized	2,000 (6' 6 3/4 ")	27689
		2,500 (8' 2 7/16")	30328
		3,000 (9' 10 1/8 ")	27688
		4,000 (13' 1 15/32")	30330
		6,000 (19' 8 7/32")	27687
		cut to size	27698



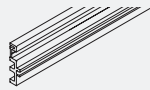

Spacer tracks

		mm (inch)	No.
	Spacer track, for wall mounting, plastic, gray	2,000 (6' 6 3/4")	057.3054.200
		cut to size	057.3054.990

Panel end component set, 53 mm (2 3/32"), aluminum

		No.
Panel end component set, left, 53 mm (2 3/32"), anodized		30145
Panel end component set, right, 53 mm (2 3/32"), anodized		30146





Set consisting of:

		30145	30146	No.
	Panel end component B, left, 53 mm (2 3/32"), aluminum, anodized	1		30034
	Bracker connector, steel, zinc-plated	1	1	057.3051.101
	Screw, M4x2.6 mm (5/32"x 1/8"), steel, zinc-plated	2	2	011.0101.171
	Panel end component B, right, 53 mm (2 3/32"), aluminum, anodized		1	30036

Panel end component set, 60 mm (2 3/8 "), aluminum

		No.
Panel end component set, left, 60 mm (2 3/8"), anodized		30147
Panel end component set, right, 60 mm (2 3/8"), anodized		30148

Set consisting of:

		30147	30148	No.
	Panel end component B, left, 60 mm (2 3/8"), aluminum, anodized	1		30030
	Bracker connector, steel, zinc-plated	1	1	057.3051.101
	Screw, M4x2.6 mm (5/32"x 1/8"), steel, zinc-plated	2	2	011.0101.171
	Panel end component B, right, 60 mm (2 3/8"), aluminum, anodized		1	30035

Soft close SoftMove 80



For soft closing in opening and closing direction order 2 sets.

		No.
	Soft closing mechanism SoftMove 80	22444

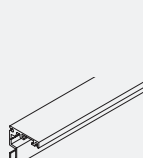
Angled profiles for wall mounting



		mm (inch)	No.
	Angled profile for wall mounting, aluminum, anodized, pre-drilled	2,500 (8' 2 7/16")	24947
		4,000 (13' 1 15/32")	24946
		6,010 (19' 8 5/8 ")	24945
		cut to size	24948

Individual components to angled profile

		No.
	Assembly set to angled profile, 10-piece set	17786
	Cover cap to angled profile, both sides, steel, chrome-plated, matt	24932
	Connecting pins to profiles, 2-piece set	21347



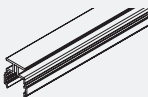
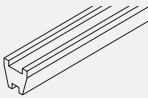
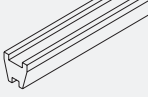
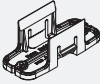

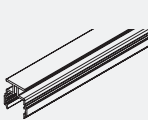
Hawa Adapto 80 concrete casting system, without fixed glazing

	No.
Inset profile for concrete surfaces Hawa Adapto 80, without fixed glass, 2500 mm (8'2 7/16")	20216
Inset profile for concrete surfaces Hawa Adapto 80, without fixed glass, 4000 mm (13'1 15/32")	20217





	mm (inch)			No.
		20216	20217	
Set consisting of:				
	2,500 (8' 2 7/16")	1		20087
	1,000 (3' 3 3/8 ")	2	4	19418
	500 (1' 7 11/16")	1		19556
		4	5	19344
		2	2	19366
	4,000 (13' 1 15/32")		1	20088

Assembly set for Hawa Adapto 80

	No.
Assembly set, with countersunk head screw, length up to 2500 mm (8'2 7/16")(8'2 7/16")	22841
Assembly set, with countersunk head screw, length 2501–4000 mm (8'2 15/32"–13'1 15/32")	22842

Set consisting of:			No.
	22841	22842	
	2	2	19398
	2	2	19399
	2	2	19400
	4	4	19401
	1	2	22844

Accessories

	No.
	24957
	24956
	21473
	20773
	25958

Further installation examples

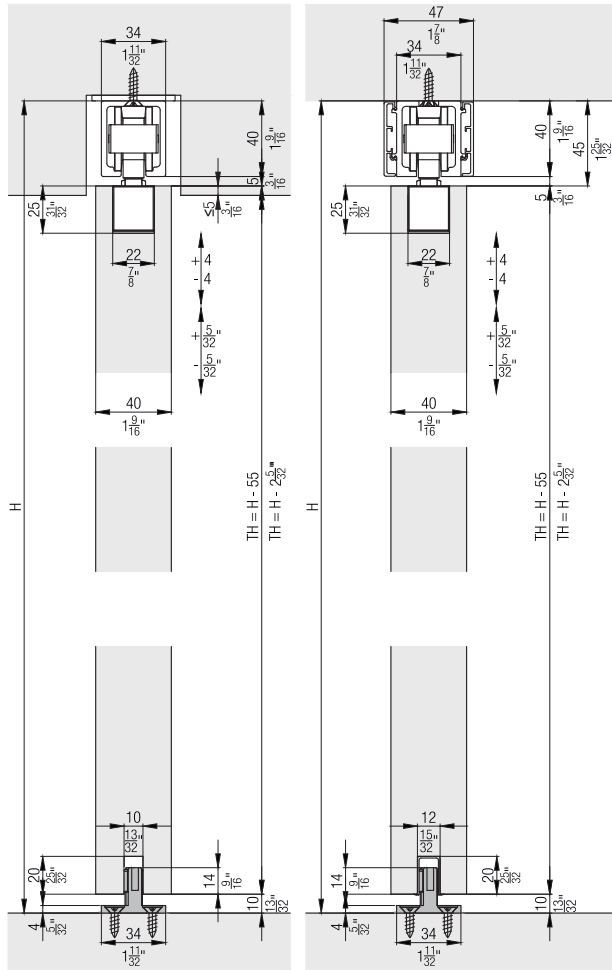

Calculations of clip-on panels

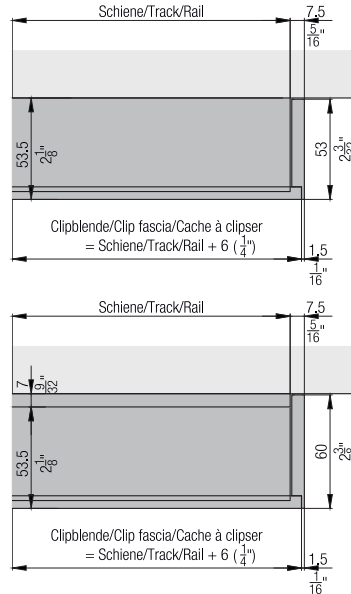

Angled profile for wall mounting

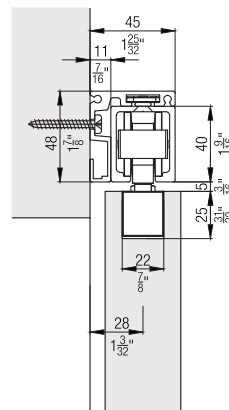

Further installation examples with spacer track

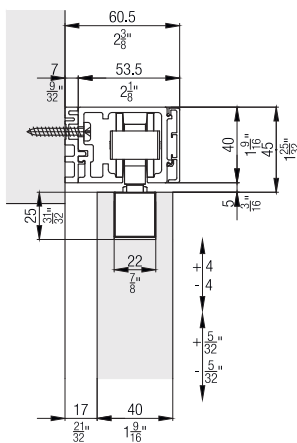

Hawa Adapto 80 concrete casting system

The Hawa Adapto 80 concrete casting system can be easily and efficiently integrated into the building shell and allows Hawa Junior 80 running tracks to be installed flush with the ceiling.

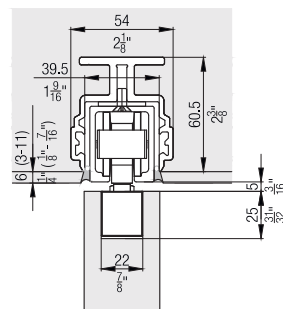

Hawa Confort 120

The convenient solution for inadequate fastening options in brittle sub-floors or in the area of floor heating. This bottom guide is mounted on the wall. Details and accessories from page 371.

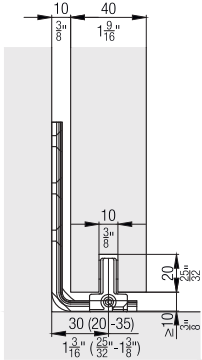

Version with 20 mm (25/32") longer hanger bolt

Thanks to the 24851 set, the running track can be covered from below, using removable ceiling elements.

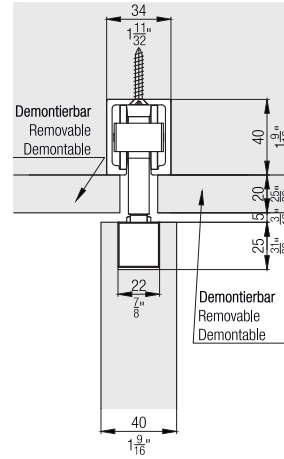

Ceiling integration

Recommendation: For systems integrated into the ceiling, provide assembly openings or front access to the system – front access of SoftMove is always mandatory.

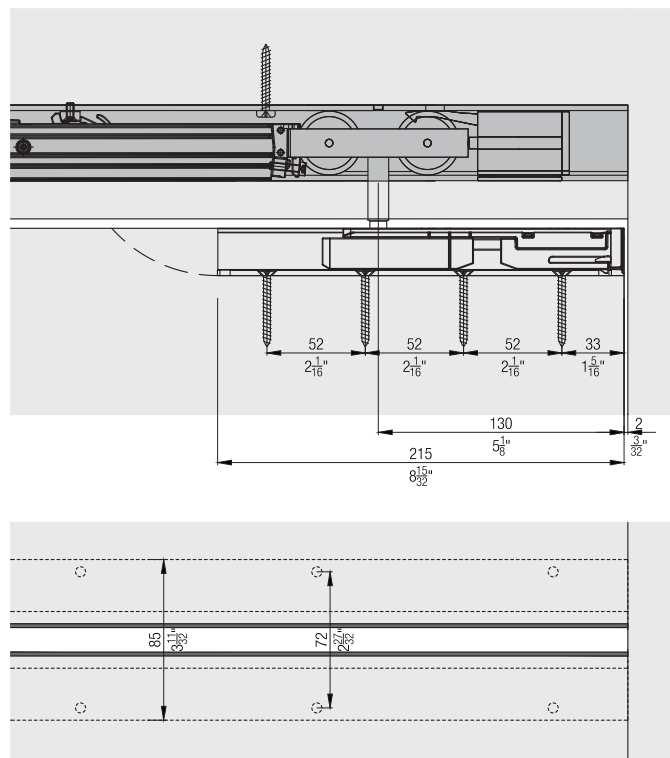
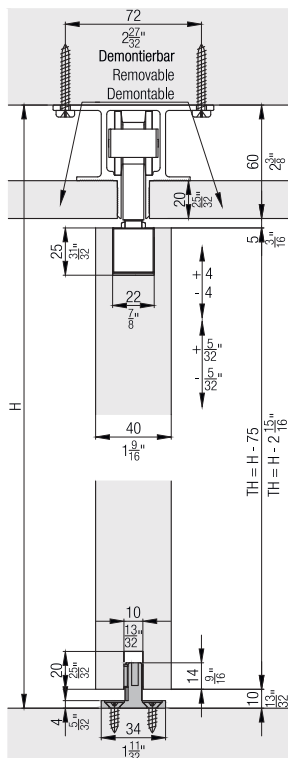

SoftMove 80 soft closing mechanism

Completely integrated into the running track, the SoftMove decelerates sliding doors and draws them into their final position.

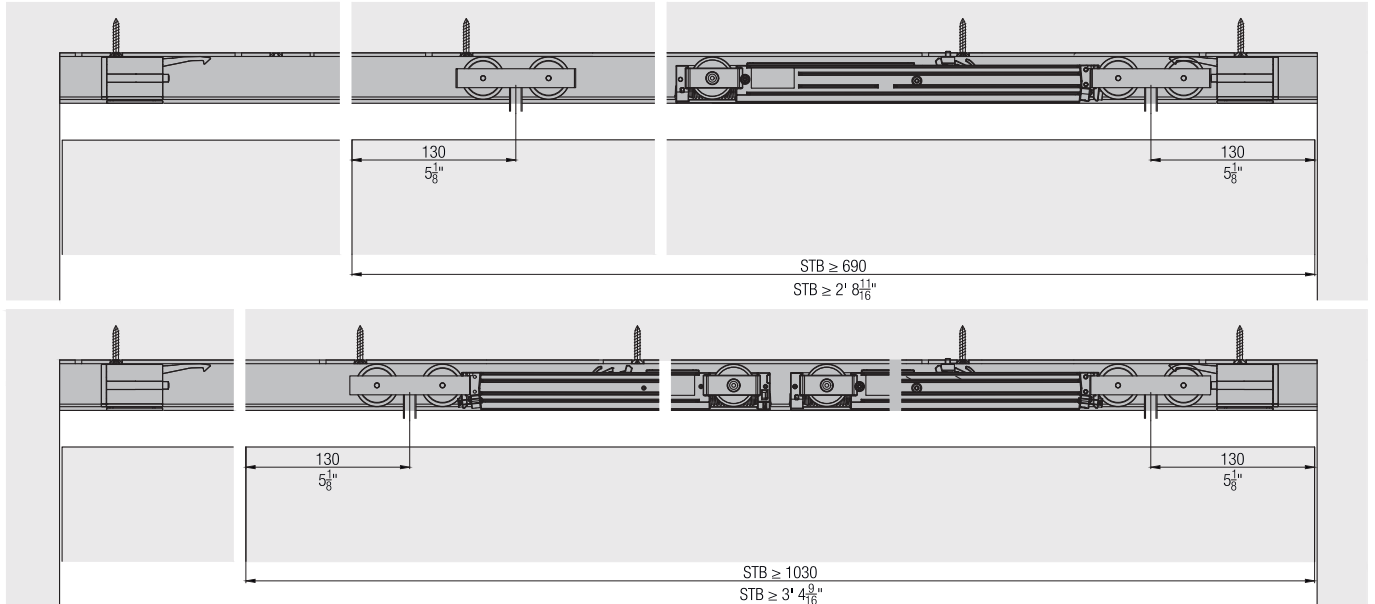

Accessories

- Hawa Junior bottom guides for wall mounting from page 371
- Lock solutions from page 374
- General accessories from page 381

Planning/execution

HAWA Junior 80 B mod. is now called Hawa Junior 80 B. Same product – new name.

Further information about the product can be found on www.hawa.com.